

Sash Window Specialist

“ADVANCED SOLUTIONS FOR HISTORIC WINDOWS”

Midlands - UK

James Smith

E-Mail: james@sashwindowspecialist.com
Tel: 01509 821528 **Mobile:** 0771 204 5541

W.A. - Australia

Simon Free

E-Mail: simon@sashwindowspecialist.com
Tel:(08) 95373697 **Mobile:** 04 33997759

North West - UK

Ged Barnes

E-Mail : ged@sashwindowspecialist.com
Tel: 01204 708650 **Mobile:** 07958 736 454

N.S.W. - Australia

Frazer Palmer

E-Mail: frazer@sashwindowspecialist.com
Mobile : 0412 935984

South East - UK

E-Mail : gary@sashwindowspecialist.com
FREEPHONE: 08003800540
Mobile: 0044 7748 648429

Yorkshire - UK

Rob Willis

E-Mail : rob@sashwindowspecialist.com
Tel: 01423 709072 **Mobile:** 07891 842066

WWW.SASHWINDOWSPECIALIST.COM

WWW.SASHWINDOWS.COM.AU

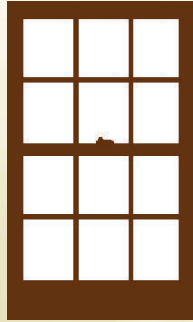

Sash Window Specialist

“ADVANCED SOLUTIONS FOR HISTORIC WINDOWS”

Thank you for your interest in Sash Window Specialist. We have pleasure to enclose some information relating to our services.

We offer a complete restoration service for all types of traditional wooden windows, restoring them to their original working order, with the added benefits of high performance draught seals. The greatest and most cost effective energy saving comes from eliminating draughts. By effectively sealing the perimeter gaps our system not only prevents draughts, but also eliminates rattles, reduces noise and pollution levels as well as cutting heating bills. Our system leaves the appearance of the window unaltered and so is especially suited to period property.

Double-glazing offers greater advantages for both sound and thermal insulation. We can supply double glazed replacement sashes that authentically match the originals. A full range of glazing options are available including acid etched designs, security glass, thermal and acoustic insulating glass. Our replacement joinery is manufactured from the finest, close grain softwoods or hardwoods. Traditional mortise and tennon construction ensures a product of the highest standard.

Our company structure is based around a co-operative of individual tradesmen from around the country. We are all qualified tradesmen with the patience and skills necessary for this type of specialised restoration work. Our aim is to provide a service of the highest quality at a very competitive price. Much of our work comes from recommendations - we understand that your satisfaction and subsequent recommendations are our future.

For a free inspection and estimate without obligation. simply contact your local office. We hope that you will find the enclosed of interest, and look forward to hearing from you in the near future.

Yours Sincerely,

The Sash Window Specialist Team

WWW.SASHWINDOWSPECIALIST.COM

WEATHERSEALS

AIR PENETRATION RESISTANCE
& WATER TIGHTNESS TEST
TO BS 6375 & BS 5368

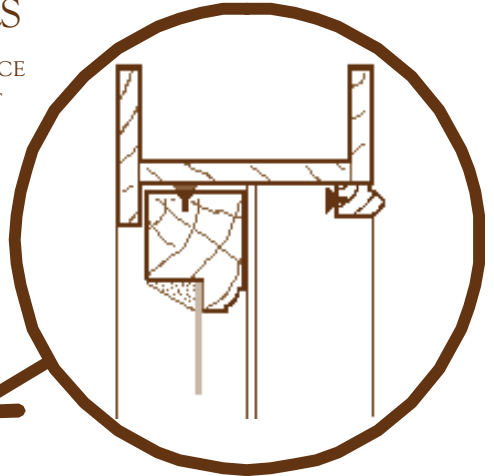
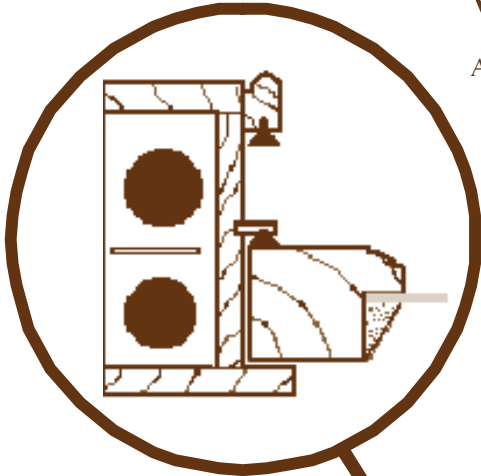

Increased comfort
and warmth with
full functionality
restored to your
windows.

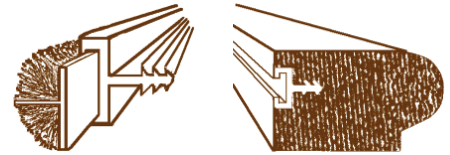
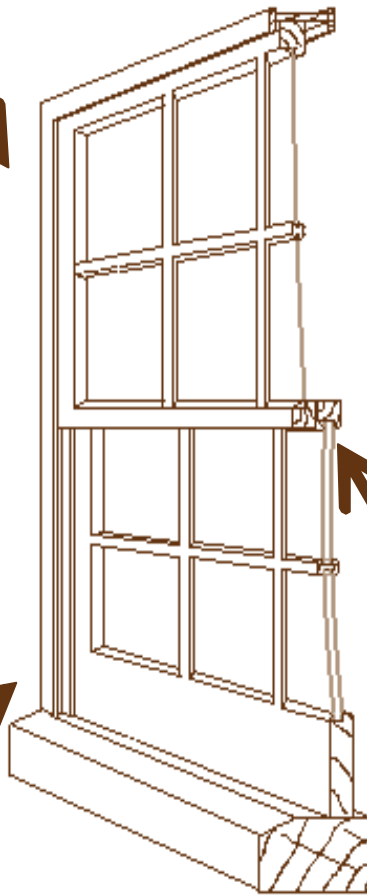

TRADITIONAL TIMBER PROFILES WITH
BUILT IN WEATHERSEALS.

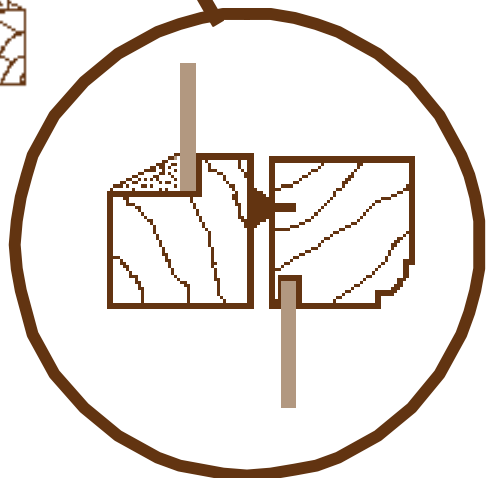
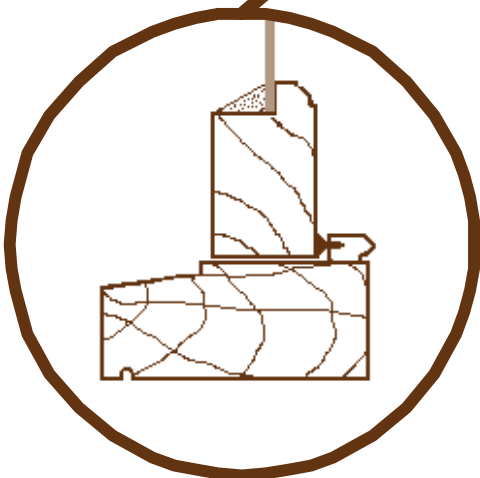
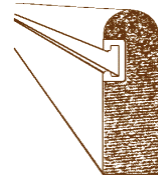

Our Recondition service is designed to leave your windows fully functioning, as they were intended, but without the age old problems of cold draughts and rattles. All of our seals are unobtrusive, so as not to detract from the charm of your original box sash windows. A wide range of glazing options are also available to improve security, privacy or noise intrusion

STEP BY STEP

- ◆ Once the dust sheets are adequately protecting your property, the sashes and weights are removed.
- ◆ Any necessary repair or re-glazing work is undertaken.
- ◆ The inner face of the box is prepared and repainted with a quick drying, low odour paint.
- ◆ The sashes are inspected and any loose joints secured & filled.
- ◆ Sashes are machined to accept our concealed, discreet weatherseals at the head and meeting rail.
- ◆ The weighting mechanism is balanced and adjusted, pulley wheels oiled and replacement long lasting cords installed.
- ◆ When re-hanging, the sashes are resized as required to leave the meeting rails as flush as possible.
- ◆ Replacement wooden beads with an integral weatherseal are fitted ensuring a low friction, high performance seal.
- ◆ Replacement catches & lifts are fitted or existing hardware serviced.
- ◆ A range of security locks and stops can be installed.
- ◆ Once the clearing and vacuuming work is complete, you will be asked to inspect your fully restored windows.

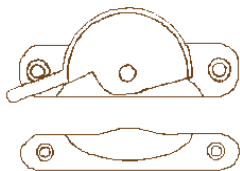

REPLACEMENT WINDOW FURNITURE

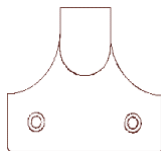

SECURITY STOPS
 Provide a secure ventilation gap by restricting the opening area—also suitable as a child lock.
 Key required to remove.

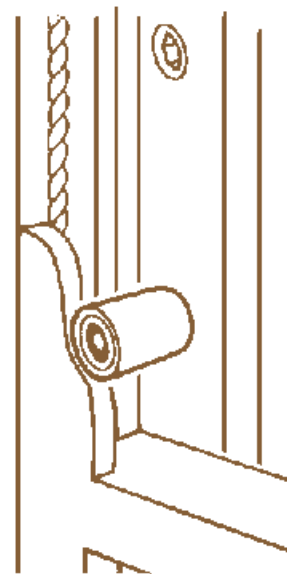
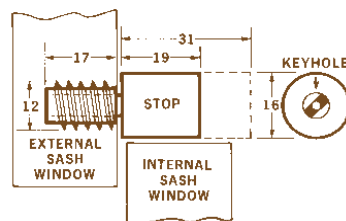

Sash
 Window
 Specialist

ORIGINAL SECTIONS

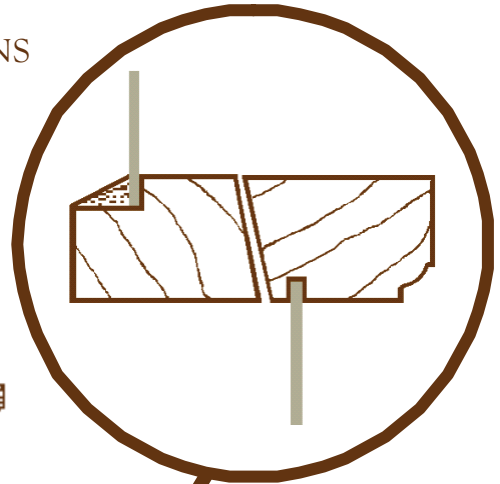

The thermal and acoustic benefits of double glazing, whilst retaining the original character of your property.

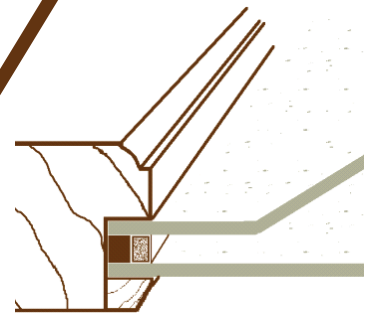

3 - 6 - 4 Glazing configuration.
Textured and safety glass available

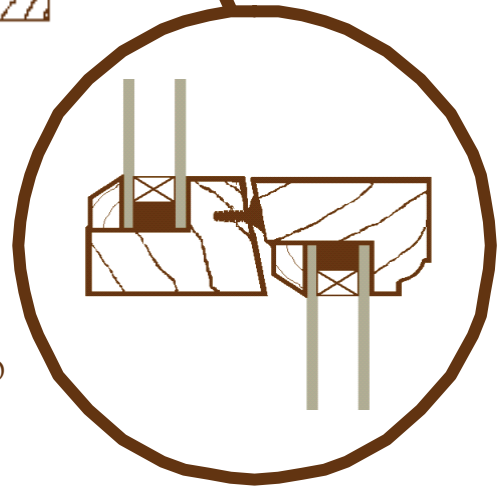
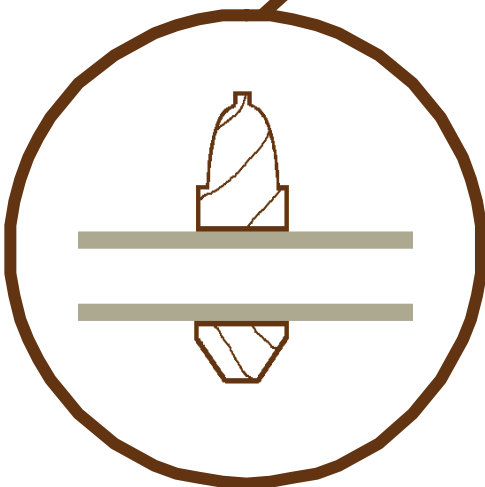

DOUBLE GLAZED SECTIONS

Our Recondition service is designed to leave your windows fully functioning, as they were intended, without the age old problems of cold draughts and rattles. However for many the cold glass, condensation and noise levels that standard single glazing offers is no longer acceptable.

Just as our draughtseals are designed to be unobtrusive, so are our replacement glazing options, retaining the charm of your traditional box sash windows.

SINGLE GLAZING

Replacing your standard float glass with laminated glazing will reduce noise intrusion as well as improve the safety and security of your home.

Low E laminated glass is also available to improve the thermal benefits of your windows.

DOUBLE GLAZING

REPLACEMENT DOUBLE GLAZED TIMBER SASHES

The simplest way to double glaze an existing sash window is to manufacture replacement sashes to match the originals. Made from selected softwood or hardwood and crafted using traditional construction, to ensure joinery of the highest quality. Supplied fully finished with double glazed units installed, three coats of paint, and supplied with window furniture and security fittings.

CONVERT YOUR EXISTING TIMBER SASHES

Sometimes it is possible to convert your existing wooden sashes to accept double glazed units. This option is generally reserved for 'special' sashes where the replacement cost of new sashes is prohibitive. Examples include arched heads, bowed frames, intricate glazing bars etc. The sashes must be in a reasonable state of repair and at least 42mm thick. Any loose joints are secured before being machined and re-glazed. Supplied with window furniture and security fittings



WWW.SASHWINDOWSPECIALIST.COM
WWW.SASHWINDOWS.COM.AU